

Series 63

Aluminium Roller Shutters



Consisting of individual interlocking aluminium slats the Series 63 Roller Shutter is designed to provide security for applications such as shopfronts, shopping centres, storage areas and counters, and can be provided with visual access or ventilation.

FEATURES

- Interlocking aluminium slats
- Light and easy to operate
- Optional vision/ventilation

DOOR DIMENSIONS

- Maximum Height: 3000mm*
- Maximum Width: 3500mm*

*Total size must not exceed 9m².

NOTE: Size restrictions may occur for external applications. Consult manufacturer for further information.

RECOMMENDED SPECIFICATIONS

Series 63 aluminium Roller Shutter with 63mm high slats in 1.2mm thick material as manufactured by Airport Doors. The Roller Shutter operates by means of a flexible curtain made of interlocking aluminium slats winding onto an overhead drum and guided in aluminium door guides.

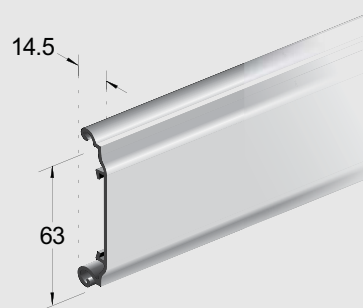

© Copyright 2015 Czapp Pty Ltd trading as Airport Doors. In line with Airport Doors' research and development program, Airport Doors reserves the right to change specifications at any time without notice.

Series 63

Aluminium Roller Shutters

CURTAIN

The Series 63 curtain is manufactured from 63mm high by 1.2mm thick specially extruded interlocking aluminium slats. Alternating slats are fitted with nylon end clips to prevent lateral movement of the curtain and to ensure smooth operation.

FINISH

Aluminium slats are available in natural anodised as standard, and can be colour anodised or powder coated when specified.

VENTILATION (OPTIONAL)

Ventilation can be provided, when specified, by slotting the individual interlocking slats. Slots are 89mm wide by 28mm high at 54mm intervals. The slotting may be applied to any number of slats as specified. Fully slotted slats achieve airflow of approximately 24%. Size restrictions may apply where shutter is fully slotted or installed in external applications. Consult manufacturer for further information.

VISION PANELS (OPTIONAL)

Clear acrylic can be fitted to the back of slotted aluminium slats to prevent wind and dust from coming through whilst still providing visual access. Alternatively, translucent acrylic panels may also be available.

BOTTOM RAIL

The bottom rail is manufactured from 1.4mm specially extruded aluminium section (measuring 90mm in height), and is fitted with a PVC bottom weather-seal.

DOOR GUIDES

Series 63 standard door guides are manufactured from 2mm thick, 50mm x 30mm extruded aluminium. Where the opening is uneven or not plumb, door guides are used in conjunction with 'take-up' channels (limitations may apply).

DRUM & SPRING ASSEMBLY

The drum is manufactured from galvanised spiral duct tube revolving around a central steel axle and encasing helical torsion springs matched to suit door size and weight. The drum is attached to nylon drum wheels, which provide bearing support to the shaft, and completely conceal the springs. The drum is designed to provide minimal deflection over the door width.

DRUM SUPPORT BRACKETS

Series 63 Roller Shutter drum support brackets are manufactured from either mild steel plate with a thickness of

3mm, or mild steel angle brackets both matched to suit door size and weight. The drum support brackets are prime-coated and are fixed to the wall using masonry anchors or hex head screws, or as specified for steel work.

FIXING REQUIREMENTS

The building construction (typically timber, steel or solid brick) must be structurally sound and have adequate strength to support the Roller Shutter and its fixing requirements. Consult manufacturer for further details.

LOCKING

Hand operated Series 63 Roller Shutters will be fitted as standard with a low profile lock which is identically keyed on both sides. The lock will be fitted to the bottom rail as standard and allow full opening height. When specified the lock can be fitted at waist height.

Alternatively, master key locking is also available upon specification. Master key is available as key operated from outside and 'dead' latch on inside. Where required 'free' (hand) latch can be provided on the inside upon specification. Master key can also be provided keyed on the outside and reverse key on the inside when specified.

NOTE: Master key locks protrude out from the bottom rail, therefore the full opening height cannot be provided (the bottom rail will sit under the lintel in the fully open position).

A shoot-bolt system is also available as an alternative locking option. Padlocks not included.

NOTE: Where door is motorised a manual lock, as discussed above, is not fitted.

MULLIONS (OPTIONAL)

Centre door mullions can be used for wide openings to create multiple door installations. Series 63 standard centre mullions, of either removable or fixed type, are manufactured from extruded aluminium of 125mm width.

Removable mullions are designed to give full opening width. A removable centre mullion consists of a lift-out mullion that locks into the bottom plate with locking pins and fits into the mullion head under the lintel. A fixed type mullion is fixed to the floor and lintel.

Corner mullions are used when two shutters meet in a corner. The mullion is manufactured from aluminium sheets fabricated to suit the angle and size as required. The width of the angular corner mullions can be minimised if the drums are vertically staged when installed.



Series 63

Aluminium Roller Shutters

OPERATION

Roller Shutters operate by means of a flexible interlocking aluminium curtain, winding onto an overhead drum and guided in aluminium door guides. Series 63 Roller Shutters can be installed 'behind-fix' or 'between-fix' and are available as hand operated or motorised.

HAND OPERATION

Hand operation of Series 63 Roller Shutters is suitable up to 2400 high by 2500 wide.

MOTORISATION

Standard motorisation is via a 24v DC motor with a wall push-button that opens and closes the door. The operator plugs into a standard GPO and consists of an emergency manual release mechanism in case of power outage.

Alternatively Series 63 aluminium roller shutters can be motorised using a tubular motor fitted inside the drum. Tubular motors are available in single-phase 240v or 24DC/240v. A manual override mechanism is available to enable manual operation in case of power outage.

Operator selection is dependent on the door size, door weight and the door's application.

The provision of adequate mains power supply and GPO or isolator (as required) to motor location is the responsibility of

the client. Wiring from the isolator and commissioning of the door, motor controllers and any ancillary hardware is by client, unless otherwise stated in writing.

Optional extras, such as access control accessories (e.g. remote control, key switches etc.) and photo electric beams for added safety, are available upon specification. For further information see Door Operators & Accessories.

NOTE: Where between-fix is required, tubular motor is used as standard.

OPTIONS

- Tapered bottom
- Mullions: removable or fixed
- Vision/Ventilation
- Between-fix installation



Series 63

Technical Specs: Aluminium Roller Shutters

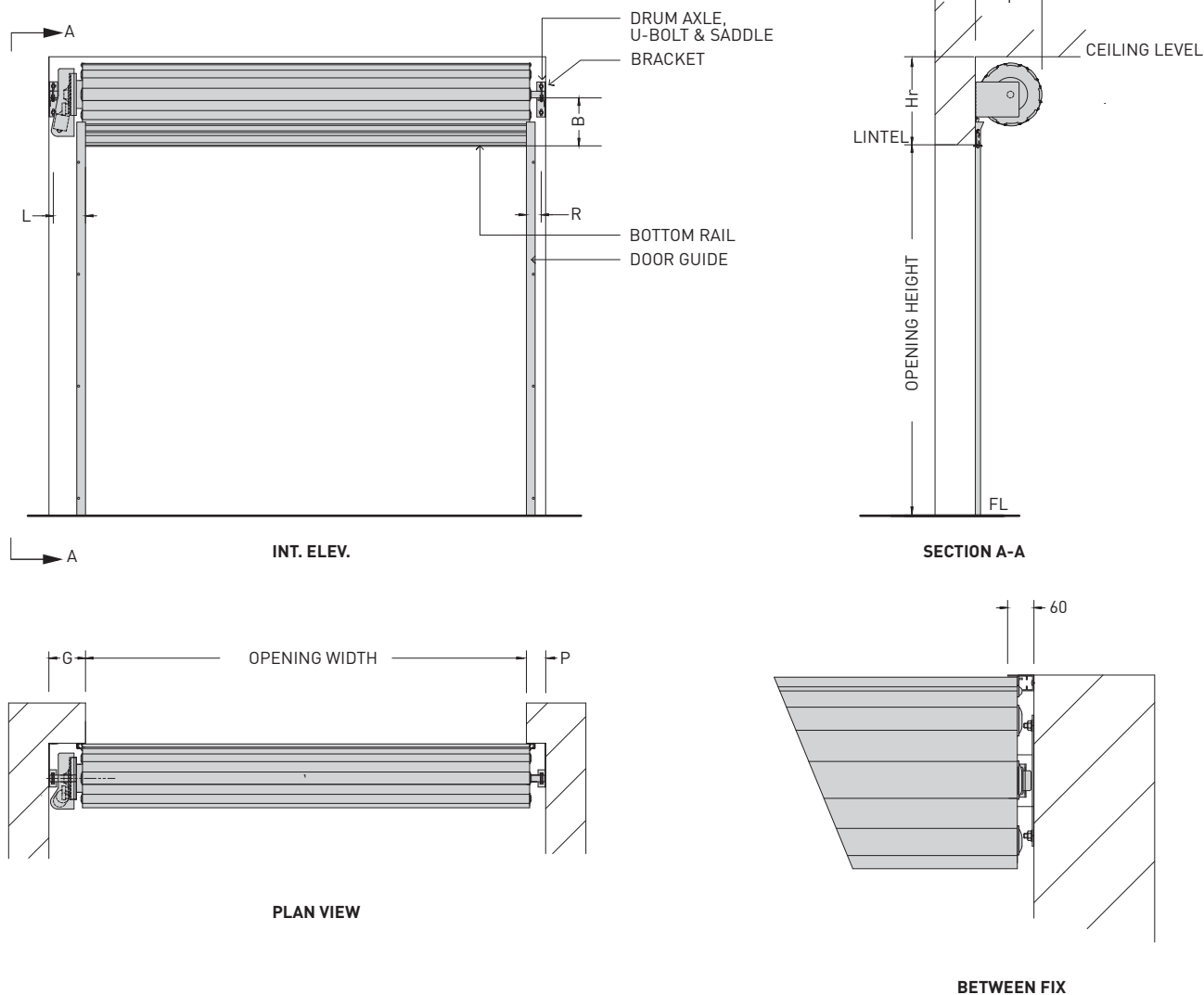

CLEARANCE DETAILS (Behind Fix)

HEIGHT UP TO	WIDTH UP TO 3m			WIDTH UP TO 3.5m			OPERATION	DRIVEN END		PLAIN END	
	Hr	B	I	Hr	B	I		G*	L	P*	R
1100	450	300	260	450	300	260	HAND OPERATION	P	R	100	70
1700	480	320	290	480	320	290	MOTORISATION (STD)	250	190	100	70
2500	540	340	350	540	340	350	MOTORISATION (TUBULAR)	100	80	100	70
3000	560	350	370	600	390	400					

Notes:

- *For 'between-fix' installation, G & P = 0.
- Total door size must not exceed 9m².

Door Guides

Technical Specs: Aluminium Roller Shutters

SERIES 25 STANDARD DOOR GUIDES

BEHIND WALL FIXING

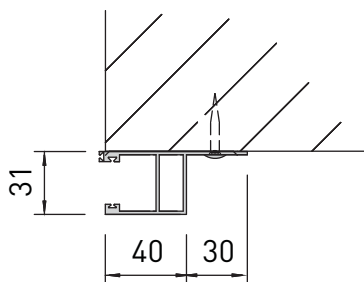

Aluminium Guide

BETWEEN WALL FIXING

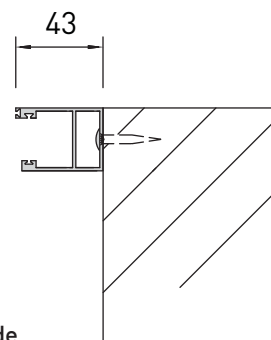

Aluminium Guide

SERIES 63 & CLEARLITE STANDARD DOOR GUIDES

BEHIND WALL FIXING

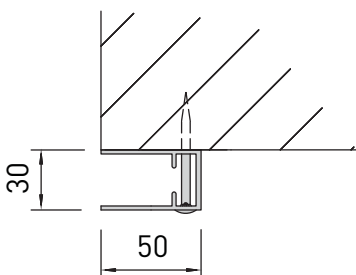

Aluminium Guide

BETWEEN WALL FIXING

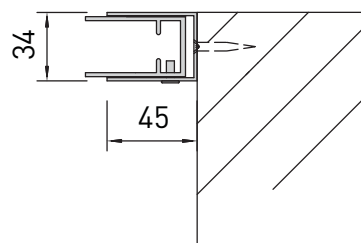

Aluminium Guide With Take Up Channel

PANORAMA STANDARD DOOR GUIDE

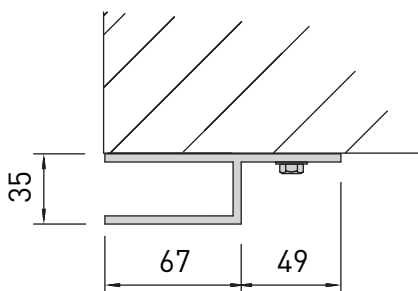

SUPA SLAT INSULATED & NON INSULATED STANDARD DOOR GUIDE

